

System 3R

Gremotool clamping devices & System 3R

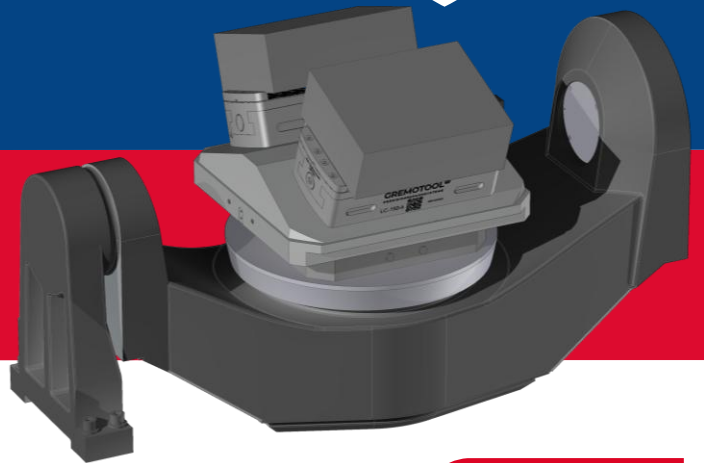

swiss
made 



Overview

Gremotool clamping devices with System 3R

Overview	2
Product presentation	3
Overview of products	10
Variant table	12
System 3R Macro	12
System 3R MacroMagnum	14
System 3R GPS-70	17
System 3R GPS-120	19
System 3R GPS-240	21
System 3R Dynafix	25
System 3R Delphin	29
Applications	34
Zero-point clamping systems	34
Gremotool Fixture	35
Accessories	36
Imprint	38

Product presentation

Gremotool clamping devices with System 3R

The automated production requires flexible and precise clamping devices. System 3R's zero-point clamping system provide a larger part of this flexibility. Different clamping devices require a common interface so that they can be customised to the requirements of the workpiece to be clamped. The ideal solution is clamping devices of Gremotool, which precisely connect the workpiece and the zero-point clamping system.



Product presentation

Advantages Gremotool with System 3R

Clamping force

The high clamping forces of the Gremotool clamping devices can be influenced by torque or pressure. This makes it possible to clamp plastic workpieces without deformation and forged parts with a secure hold without damaging the clamping device.

Centering precision

The design of all Gremotool centering vices guarantees the user precise centering of ± 0.02 mm in the centre of the clamping device.

Accessibility

The Gremotool clamping devices are suitable for various application scenarios. Accessibility for the processing machine is a key element in enabling the best possible processing strategy. They can be used directly on the zero-point clamping system, on pallets or on towers.

Compact

The compact power package fit into any machine and guarantee a firm hold of the workpiece for machining. The solid construction with low weight also allows manual re-tooling.

Enclosed and low maintenance

Due to the design of the centre clamps, no chips remain in the clamping device. This means that all components are subject to less wear, which reduces maintenance to a minimum.

Short set-up times

Gremotool clamping devices are all equipped with various connection options. No special versions for standard pallets are required to change the clamping devices, precision pins and screws are loosened and tightened again.

Large range of jaws

The jaws on all Gremotool centre clamps are interchangeable. From gripping jaws to soft jaws made of aluminium, no requirements remain unfulfilled for the demands placed on the workpieces.

Automating the process

If special requirements of the automation are placed on the clamping devices, the Gremotool clamping devices are ideal. The clamping devices can be equipped with various interfaces, including those integrated directly into the clamping device. This allows the machining area of the machine to be utilised even more optimally.

Short delivery times

The short delivery times of jaws allows to work quickly and flexibly with the Gremotool range of jaws.

Get started immediately

A pair of gripper jaws is supplied with each clamping device at no extra cost, allowing you to clamp raw parts at no additional costs.

Product presentation

PMC-50 with System 3R MacroMagnum

pneumatic /
hydraulic

Gremotool system of jaws

- + interchangeable between series
- + quick change of jaws
- + protruding jaws possible

Enclosed design with valve

- + ideal chip flow
- + 3-fold clamping reliability
- + adjustable clamping force by valve

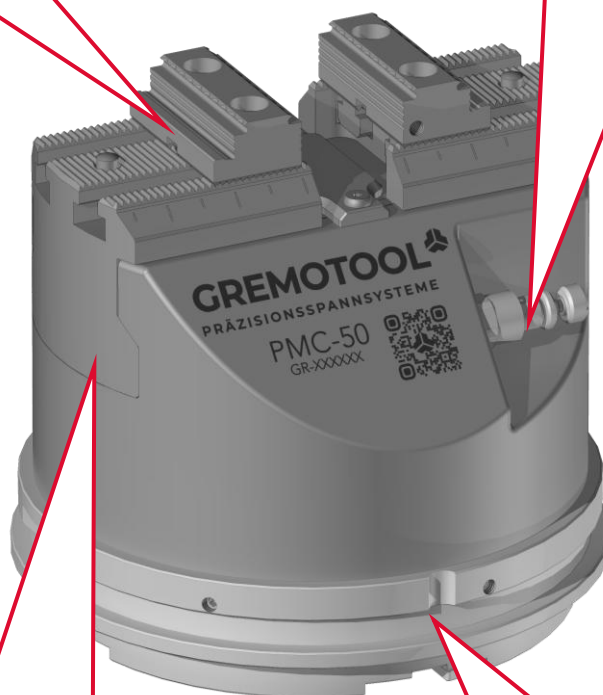

Centring precision $\pm 0.01\text{mm}$

- + precision for multi-axis machining
- + high repeat precision
- + reduces vibrations on the workpiece

Suitable with pallets of System 3R

- + designed for automation
- + deep for larger workpiece in machine
- + RFID-Chip attachable

mechanical

Product presentation

2x SC-100 with System 3R Dynafix

Gremotool system of jaws

- + interchangeable between series
- + quick change of jaws
- + protruding jaws possible

High design

- + ideal chip flow
- + high accessibility
- + idealised clamping force

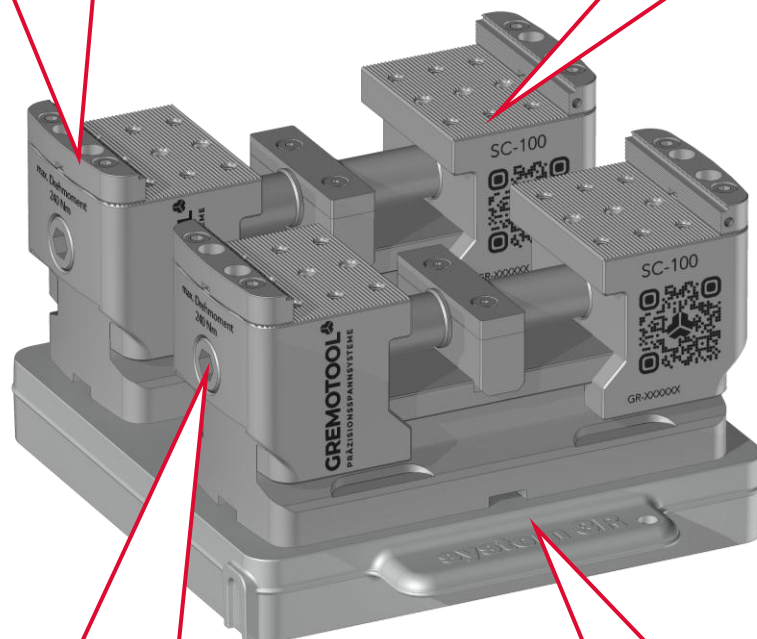

Centring precision $\pm 0.01\text{mm}$

- + precision for multi-axis machining
- + high repeat precision
- + reduces vibrations on the workpiece

Suitable with pallets of System 3R

- + e.g. on System 3R Dynafix
- + centre, left, right, left & right
- + fast, precise assembly from below

mechanical

Product presentation

VC-74 vise modules with System 3R Delphin

Gremotool system of jaws

- + interchangeable between series
- + quick change of jaws
- + protruding jaws possible

Enclosed design

- + ideal chip flow
- + high accessibility
- + idealised clamping force

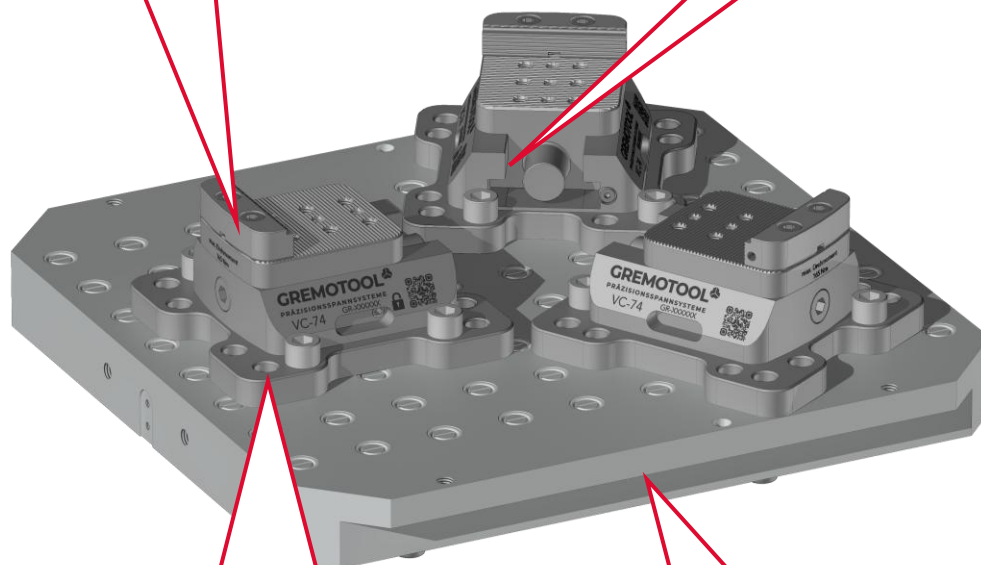

Modular design

- + Modules can be positioned individually
- + for 40mm und 50mm perforated grid
- + can be mounted by 30° for round workpieces

Suitable with pallets of System 3R

- + designed for automation
- + deep for larger workpiece in machine
- + RFID-Chip attachable

mechanical

Product presentation

LC-50 with integrated System 3R GPS-120

Gremotool system of jaws

- + interchangeable between series
- + quick change of jaws
- + protruding jaws possible

Enclosed design

- + ideal chip flow
- + high accessibility
- + idealised clamping force



Centring precision $\pm 0.01\text{mm}$

- + precision for multi-axis machining
- + high repeat precision
- + reduces vibrations on the workpiece

Integrated pallet for GPS-120

- + designed for automation
- + deep for larger workpiece in machine
- + RFID-Chip attachable

Product presentation

RC-38 with System 3R Dynafix

mechanical

Gremotool quick-change system
+ jaws quickly interchangeable
+ different jaw types
+ with pull-down effect

Modular Design
+ various modules
+ optimal accessibility
+ idealised clamping force

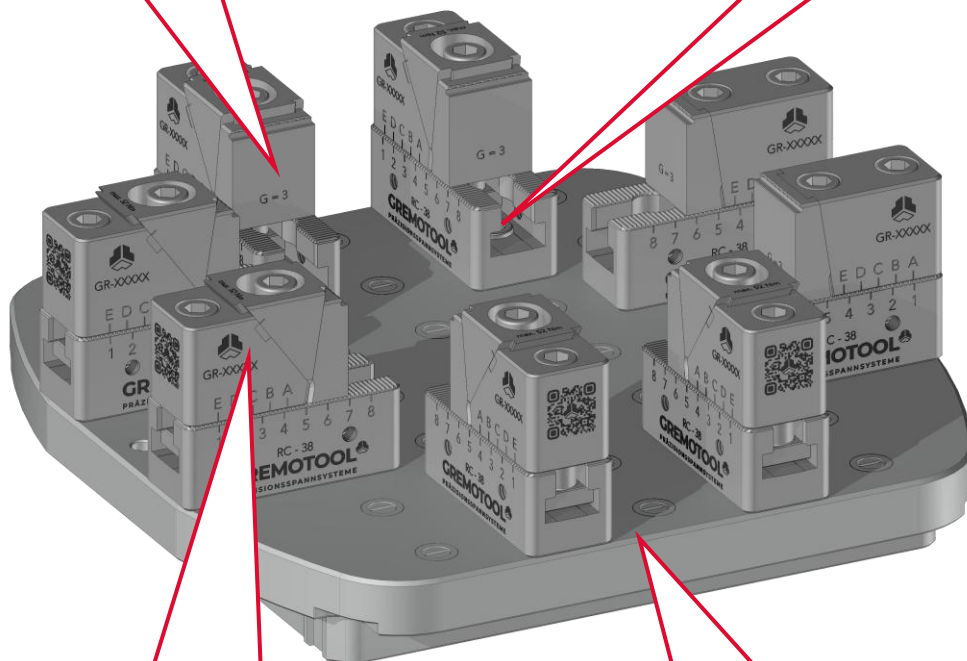









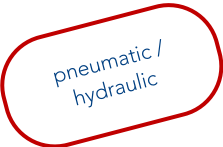

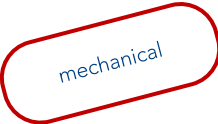

Precision +/-0.01mm
+ precision for multi-axis machining
+ high repeat precision
+ reduces vibrations on the workpiece

Can be combined with System 3R pallets
+ designed for automation
+ deep for larger workpiece in machine
+ RFID-Chip attachable





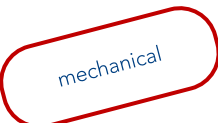





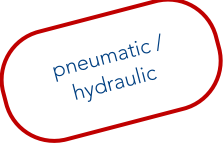

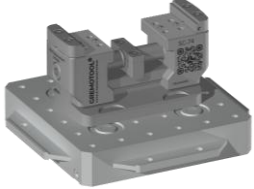
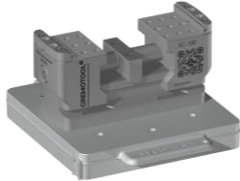
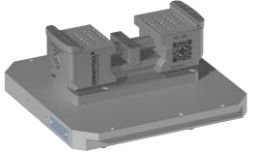

Overview of products

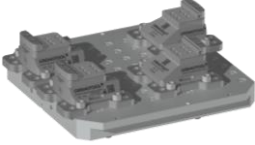
Gremotool clamping devices with System 3R

	Macro	MacroMagnum	GPS 70	GPS 120
PMC / HMC 	-	 PMC / HMC-50	-	-
SC 	 SC-34 / 40	 SC-34 / 40 / 50 / 60 / 74	 SC-34 / 40	 SC-34 / 40 / 50 / 60
VC 	-	-	-	-
LC 	 LC-34 / 40	 LC-34 / 40 / 50 / 60 / 74	 LC-34 / 40	 LC-34 / 40 / 50 / 60
RC 	-	-	-	-

Overview of products

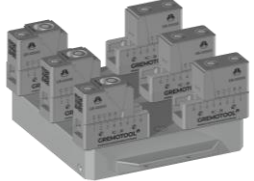
Gremotool clamping devices and System 3R

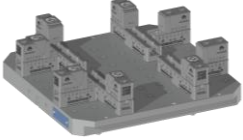
	GPS 240	Dynafix	Delphin
PMC / HMC 	 PMC-50 / 60 / 60l / 74	 PMC-50 / 60 / 60l / 74	 PMC / HMC-50 / 60 / 60l / 74 / 100 / 120
SC 	 SC-34 / 40 / 50 / 60 / 74 / 100 / 120	 SC-34 / 40 / 50 / 60 / 74 / 100 / 120	 SC-34 / 40 / 50 / 60 / 74 / 100 / 120
VC 	-	-	 VC-60 / 74 / 100 / 120 / 150
LC 	 LC-34 / 40 / 50 / 60 / 74 / 100 / 120	 LC-34 / 40 / 50 / 60 / 74 / 100 / 120 / 150	 LC-34 / 40 / 50 / 60 / 74 / 100 / 120 / 150
RC 	 RC-38	 RC-38	 RC-38

Variant table

System 3R Macro with SC

mechanical

The SC series can be mounted on the Macro pallets from System 3R without modifications.

It is also possible to attach only the reference element directly to the SC series without a superstructure.

The height of the SC series enables optimum accessibility for 5-axis machining on workpieces.

The large range of jaws also offers suitable jaws for any application.

For the exact data of the SC series, please get directly in touch with us or consult the SC catalogue.

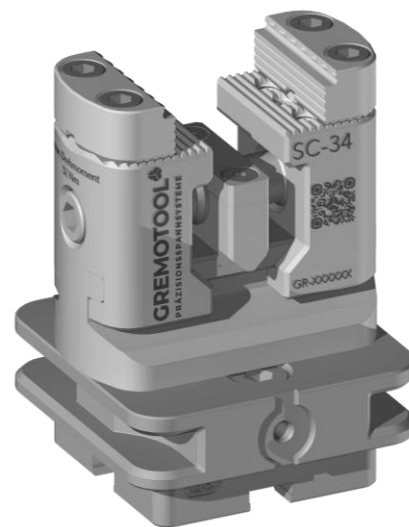

SC-34 with System 3R Macro Pallet



SC-40 with System 3R Macro Pallet

Further variants can be requested directly by Gremotool.

The shown products and option combinations are examples.
The rights by the respective products are the property of System 3R and/or Gremotool.

Variant table

System 3R Macro with LC

mechanical

The LC series can be mounted on the Macro pallets from System 3R without modifications.

It is also possible to attach only the reference element directly to the LC series without a superstructure.

Due to the enclosed design of the LC series, no chips remain on the clamping device.

The large range of jaws also offers suitable jaws for any application.

For the exact data of the LC series, please get directly in touch with us or consult the LC catalogue.



LC-34 with System 3R Macro Pallet



LC-40 with System 3R Macro Pallet

Further variants can be requested directly by Gremotool.

The shown products and option combinations are examples.
The rights by the respective products are the property of System 3R and/or Gremotool.

Variant table

System 3R MacroMagnum with PMC

pneumatic /
hydraulic

The PMC/HMC-50 is designed to fit the MacroMagnum pallet by System 3R.

This is supplied from below through the pallet using pneumatics or hydraulics.

The clamping force of the PMC can be individually adjusted to the workpiece using the reducing valve.

The large range of jaws also offers suitable jaws for any application.

For the exact data of the PMC series, please get directly in touch with us or consult the PMC catalogue.



PMC-50 with System 3R MacroMagnum Palette



**HMC-50 with System 3R
MacroMagnum-Palette**

Further variants can be requested directly by Gremotool.

The shown products and option combinations are examples.
The rights by the respective products are the property of System 3R and/or Gremotool.

Variant table

System 3R MacroMagnum with SC

mechanical

The SC series can be mounted on System 3R MacroMagnum pallets without modifications.

The height of the SC series enables optimum accessibility for 5-axis machining on workpieces.

The large range of jaws also offers suitable jaws for any application.

For the exact data of the SC series, please get in touch directly with us or consult the SC catalogue.

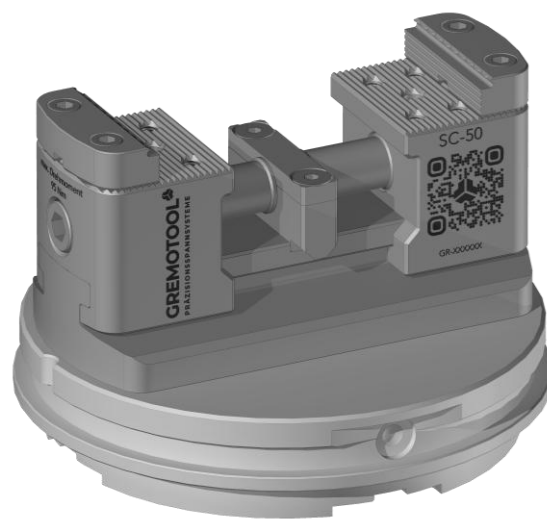

SC-50 with System 3R MacroMagnum Pallet



2x SC-40 with System 3R MacroMagnum-Pallet



SC-60 with System 3R MacroMagnum-Pallet



SC-74 with System 3R MacroMagnum-Pallet

Further variants can be requested directly by Gremotool.

The shown products and option combinations are examples.
The rights by the respective products are the property of System 3R and/or Gremotool.

Variant table

System 3R MacroMagnum with LC

mechanical

The LC series can be mounted on the MacroMagnum pallets from System 3R without modifications.

Due to the closed design of the LC series, no chips remain on the clamping device.

The large range of jaws also offers suitable jaws for any application.

For the exact data of the LC series, please get directly in touch with us or consult the LC catalogue.



LC-50 with System 3R MacroMagnum Pallet



2x LC-40 with System 3R MacroMagnum-Pallet



LC-60 with System 3R MacroMagnum-Pallet



LC-74 with System 3R MacroMagnum-Pallet

Further variants can be requested directly by Gremotool.

The shown products and option combinations are examples.
The rights by the respective products are the property of System 3R and/or Gremotool.

Variant table

System 3R GPS-70 with SC

mechanical

The SC series can be mounted on the GPS-70 pallets from System 3R without modifications.

The height of the SC series enables optimum accessibility for 5-axis machining on workpieces.

The large range of jaws also offers suitable jaws for any application.

For the exact data of the SC series, please get directly in touch with us or consult the SC catalogue.



SC-34 with System 3R GPS-70 Pallet

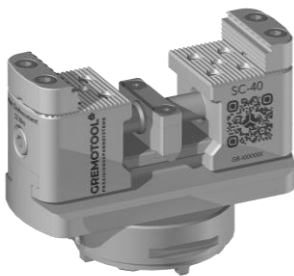

SC-40 with System 3R GPS-70-Pallet

Further variants can be requested directly by Gremotool.

The shown products and option combinations are examples.
The rights by the respective products are the property of System 3R and/or Gremotool.

Variant table

System 3R GPS-70 with LC

mechanical

The LC series can be mounted on the GPS-70 pallets from System 3R without modifications.

Due to the closed design of the LC series, no chips remain on the clamping device.

The large range of jaws also offers suitable jaws for any application.

For the exact data of the LC series, please get directly in touch with us or consult the LC catalogue.



LC-34 with System 3R GPS-70 Pallet



LC-40 with System 3R GPS-70-Pallet

Further variants can be requested directly by Gremotool.

The shown products and option combinations are examples.
The rights by the respective products are the property of System 3R and/or Gremotool.

Variant table

System 3R GPS-120 with SC

mechanical

The SC series can be mounted on the GPS-120 pallets from System 3R without modifications.

The height of the SC series enables optimum accessibility for 5-axis machining on workpieces.

The large range of jaws also offers suitable jaws for any application.

For the exact data of the SC series, please get directly in touch with us or consult the SC catalogue.

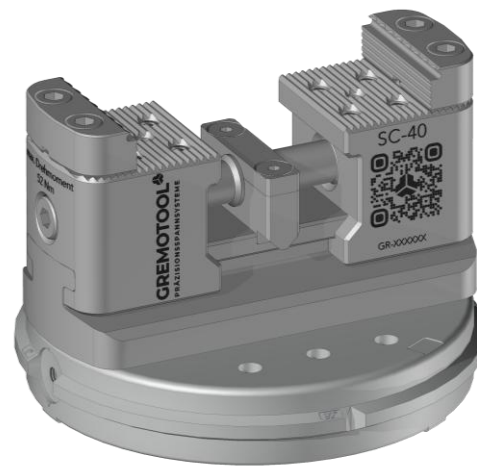

SC-40 with System 3R GPS-120 Pallet

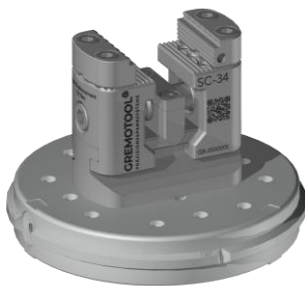

**SC-34 with System 3R
GPS-120-Pallet**

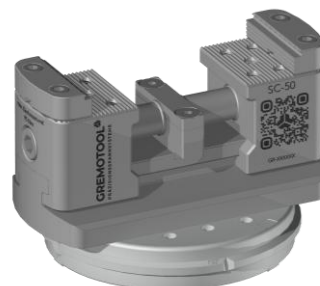

**SC-50 with System 3R
GPS-120 Pallet**



**SC-60 with System 3R
GPS-120 Pallet**

Further variants can be requested directly by Gremotool.

The shown products and option combinations are examples.
The rights by the respective products are the property of System 3R and/or Gremotool.

Variant table

System 3R GPS-120 with LC

mechanical

The LC series can be mounted on the GPS-120 pallets from System 3R without modifications.

Due to the closed design of the LC series, no chips remain on the clamping device.

The large range of jaws also offers suitable jaws for any application.

For the exact data of the LC series, please get directly in touch with us or consult the LC catalogue.



LC-40 with System 3R GPS-120 Pallet



**LC-34 with System 3R
GPS-120-Pallet**



**LC-50 with System 3R
GPS-120 Pallet**



**LC-60 with System 3R
GPS-120 Pallet**



**LC-50 with integrated
System 3R GPS-120 Pallet**

Further variants can be requested directly by Gremotool.

The shown products and option combinations are examples.
The rights by the respective products are the property of System 3R and/or Gremotool.

Variant table

System 3R GPS-240 with PMC

pneumatic

The PMC series is designed to fit the GPS-240 pallet of System 3R.

Pneumatically supplied from below through the pallet.

Using the reducing valve the clamping force can be individually adjusted to the workpiece.

The large range of jaws also offers suitable jaws for any application.

For the exact data of the PMC series, please get directly in touch with us or consult the PMC catalogue.



PMC-60 with System 3R GPS-240 Pallet



**PMC-60I with System 3R
GPS-240 Pallet**



**PMC-74 with System 3R
GPS-240 Pallet**

Further variants can be requested directly by Gremotool.

The shown products and option combinations are examples.
The rights by the respective products are the property of System 3R and/or Gremotool.

Variant table

System 3R GPS-240 with SC

mechanical

The SC series can be mounted on the GPS-240 pallets from System 3R without any modifications.

The height of the SC series enables optimum accessibility for 5-axis machining on workpieces.

The large range of jaws also offers suitable jaws for any application.

For the exact data of the SC series, please get directly in touch with us or consult the SC catalogue.

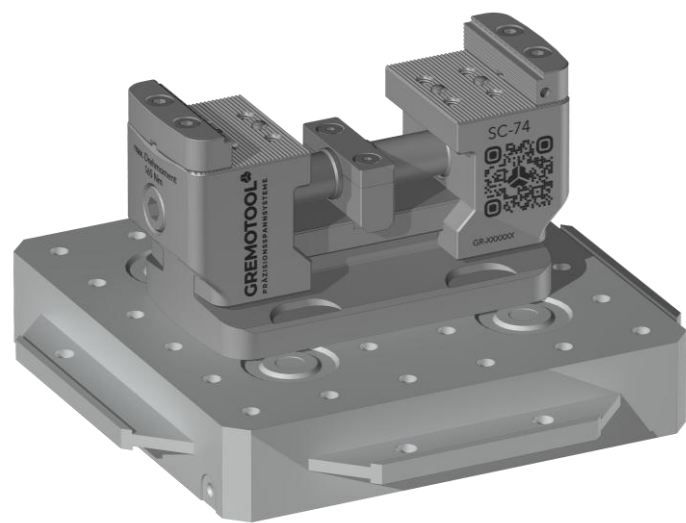

SC-74 with System 3R GPS-240 Pallet

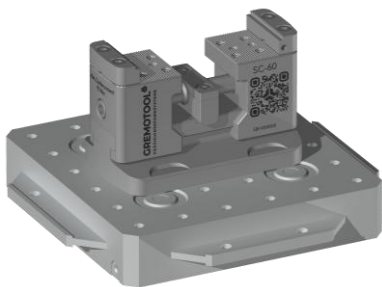

**SC-60 with System 3R
GPS-240 Pallet**

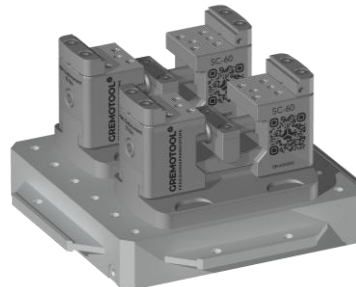

**2x SC-60 with System 3R
GPS-240 Pallet**

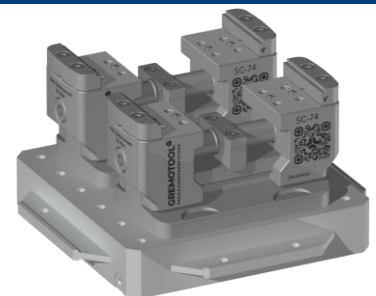

**2x SC-74 with System 3R
GPS-240 Pallet**

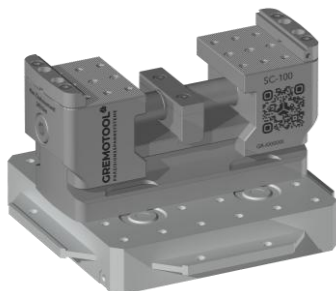

**SC-100 with System 3R
GPS-240 Pallet**

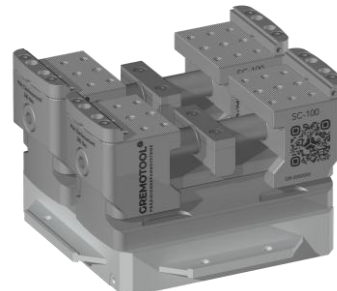

**2x SC-100 with System 3R
GPS-240 Pallet**

Further variants can be requested directly by Gremotool.

The shown products and option combinations are examples.
The rights by the respective products are the property of System 3R and/or Gremotool.

Variant table

System 3R GPS-240 with LC

mechanical

The LC series can be mounted on the GPS-240 pallets from System 3R without any modifications.

Due to the closed design of the LC series, no chips remain on the clamping device.

The large range of jaws also offers suitable jaws for any application.

For the exact data of the LC series, please get directly in touch with us or consult the LC catalogue.



LC-74 with System 3R GPS-240 Pallet



**LC-60 with System 3R
GPS-240 Pallet**



**2x LC-60 with System 3R
GPS-240 Pallet**



**2x LC-74 with System 3R
GPS-240 Pallet**



**LC-100 with System 3R
GPS-240 Pallet**



**2x LC-100 with System 3R
GPS-240 Pallet**

Further variants can be requested directly by Gremotool.

The shown products and option combinations are examples.
The rights by the respective products are the property of System 3R and/or Gremotool.

Variant table

System 3R GPS-240 with RC

mechanical

The RC-series can be mounted on the pore hole grid panels and on the GPS-240 pallets form System 3R without modifications.

The modular design of the RC-series allows different clamping situations for the workpieces.

The quick-change jaw system offers a pull-down function and the right jaw for the workpieces.

For the exact data of the RC series, please get directly in touch with us or consult the RC catalogue.

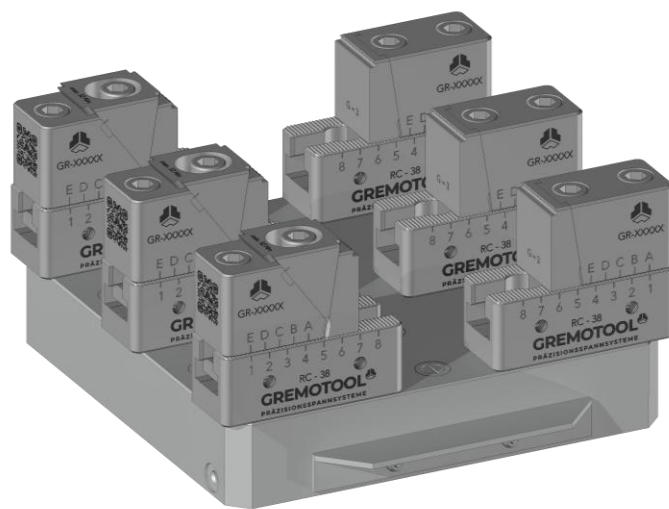

3x RC-38 with System 3R GPS-240 Pallet

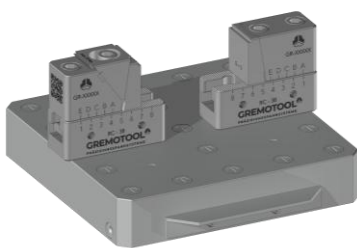

**RC-38 with System 3R
GPS-240 Pallet**

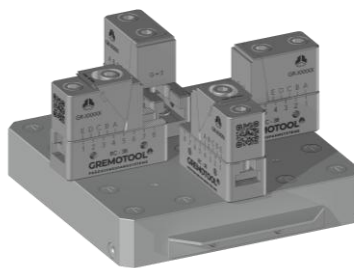

**2x RC-38 with System 3R
GPS-240 Pallet**

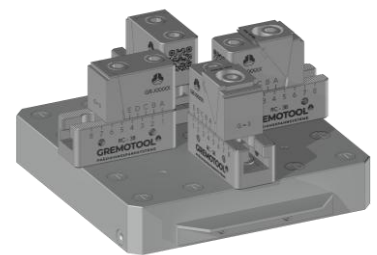

**2x RC-38 facing outwards
with System 3R GPS-240 Pallet**

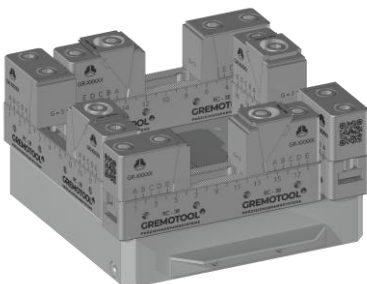

**4x RC-38 with System 3R
GPS-240 Pallet**

Further variants can be requested directly by Gremotool.

The shown products and option combinations are examples.
The rights by the respective products are the property of System 3R and/or Gremotool.

Variant table

System 3R Dynafix with PMC

pneumatic

The PMC series is designed to fit the Dynafix pallet from System 3R.

Pneumatically supplied from below through the pallet.

Using the reducing valve the clamping force can be individually adjusted to the workpiece.

The large range of jaws also offers suitable jaws for any application.

For the exact data of the PMC series, please get directly in touch with us or consult the PMC catalogue.

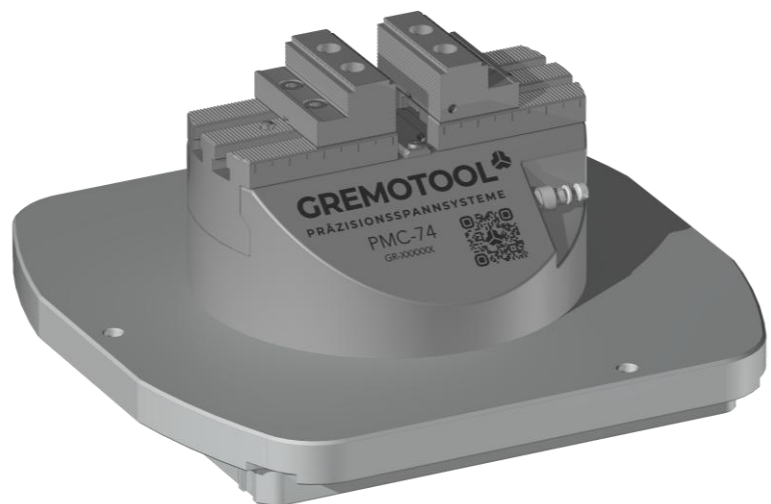

PMC-74 with System 3R Dynafix Pallet

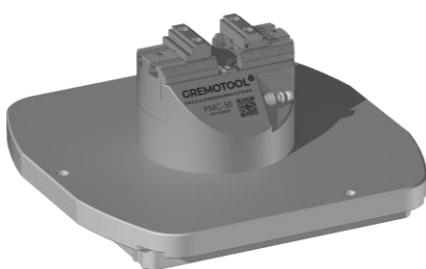

**PMC-50 with System 3R
Dynafix Pallet**



**PMC-60 with System 3R
Dynafix Pallet**



**PMC-60I with System 3R
Dynafix Pallet**

Further variants can be requested directly by Gremotool.

The shown products and option combinations are examples.
The rights by the respective products are the property of System 3R and/or Gremotool.

Variant table

System 3R Dynafix with SC

mechanical

The SC series can be mounted on the Dynafix pallets from System 3R without any modifications.

The height of the SC series enables optimum accessibility for 5-axis machining on workpieces.

The large range of jaws also offers suitable jaws for any application.

For the exact data of the SC series, please get directly in touch with us or consult the SC catalogue.

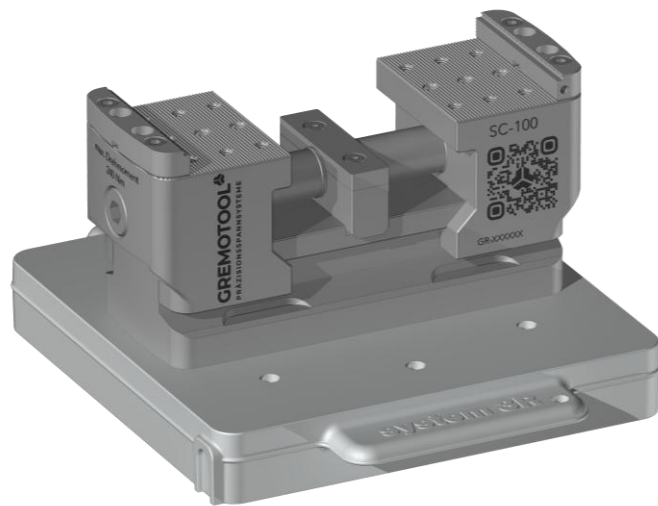

SC-100 with System 3R Dynafix Palette

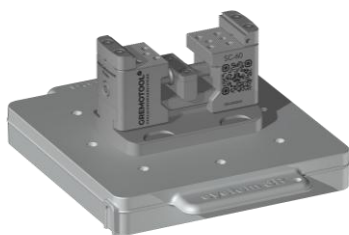

**SC-60 with System 3R
Dynafix Pallet**

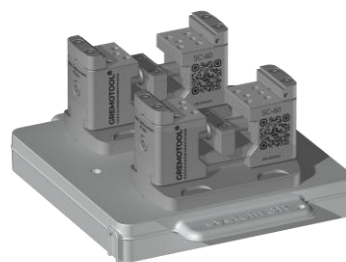

**2x SC-60 with System 3R
Dynafix Pallet**

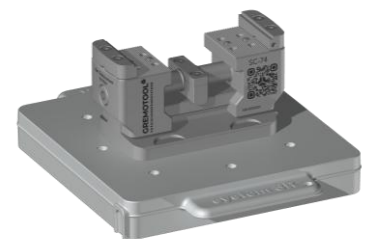

**SC-74 with System 3R
Dynafix Pallet**

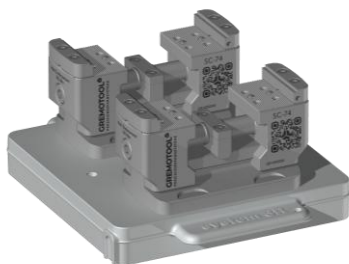

**2x SC-74 with System 3R
Dynafix Pallet**

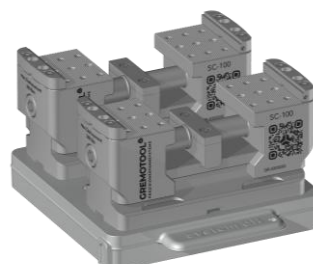

**2x SC-100 with System 3R
Dynafix Pallet**

Further variants can be requested directly by Gremotool.

The shown products and option combinations are examples.
The rights by the respective products are the property of System 3R and/or Gremotool.

Variant table

System 3R Dynafix with LC

mechanical

The LC series can be mounted on the Dynafix pallets from System 3R without any modifications.

Due to the closed design of the LC series, no chips remain on the clamping device.

The large range of jaws also offers suitable jaws for any application.

For the exact data of the LC series, please get directly in touch with us or consult the LC catalogue.



LC-100 with System 3R Dynafix Pallet



**LC-60 with System 3R
Dynafix Pallet**



**2x LC-60 with System 3R
Dynafix Pallet**



**LC-74 with System 3R
Dynafix Pallet**



**2x LC-74 with System 3R
Dynafix Pallet**



**2x LC-100 with System 3R
Dynafix Pallet**

Further variants can be requested directly by Gremotool.

The shown products and option combinations are examples.
The rights by the respective products are the property of System 3R and/or Gremotool.

Variant table

System 3R Dynafix with RC

mechanical

The RC-series can be mounted on the pore hole grid panels and on the Dynafix pallets form System 3R without modifications.

The modular design of the RC-series allows different clamping situations for the workpieces.

The quick-change jaw system offers a pull-down function and the right jaw for the workpieces.

For the exact data of the RC series, please get directly in touch with us or consult the RC catalogue.

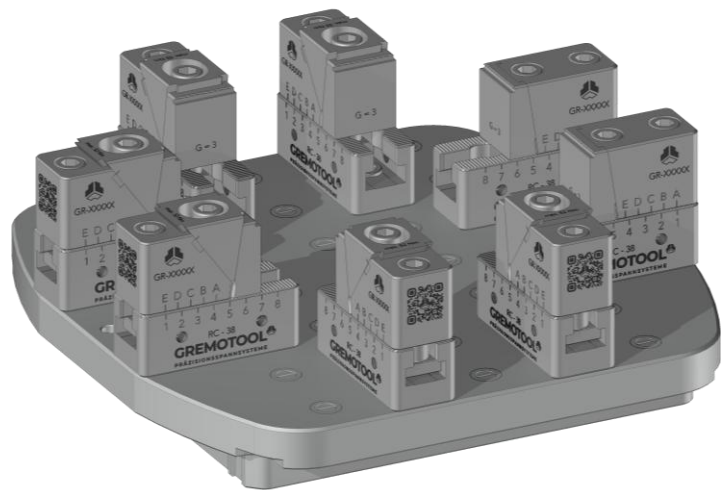

4x RC-38 with System 3R Dynafix Pallet

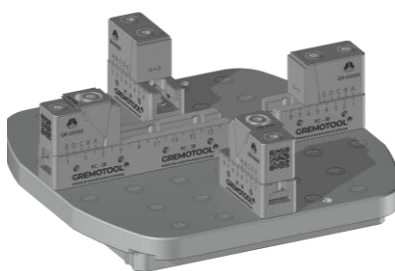

**2x RC-38 with System 3R
Dynafix Pallet**

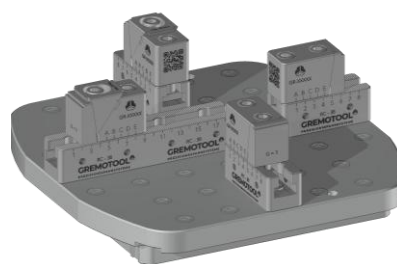

**2x RC-38 facing outwards
with System 3R Dynafix Pallet**

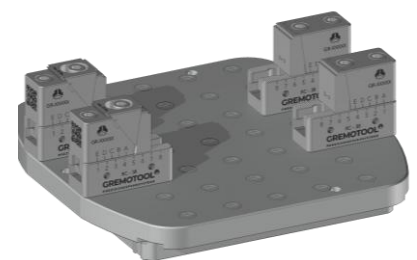

**2x RC-38 with System 3R
Dynafix Pallet**

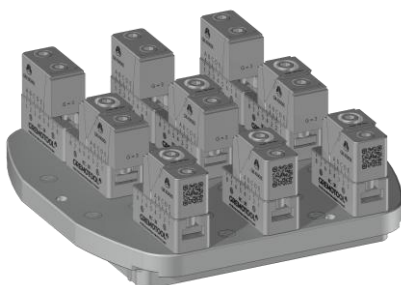

**3x RC-38 with System 3R
Dynafix Pallet**

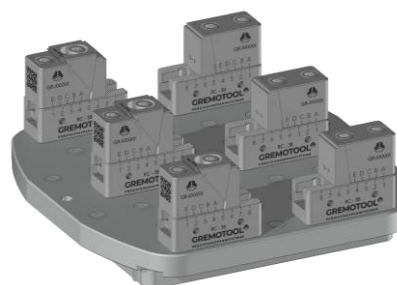

**3x RC-38 with System 3R
Dynafix Pallet**

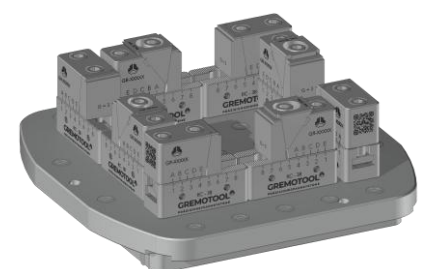

**4x RC-38 with System 3R
Dynafix Pallet**

Further variants can be requested directly by Gremotool.

The shown products and option combinations are examples.
The rights by the respective products are the property of System 3R and/or Gremotool.

Variant table

System 3R Delphin with PMC/HMC

pneumatic /
hydraulic

The PMC/HMC series is designed to fit the Delphin pallets of System 3R.

Pneumatically or hydraulically supplied from below through the pallet.

The clamping force of the PMC can be individually adjusted to the workpiece using the reducing valve.

The large range of jaws also offers suitable jaws for any application.

For the exact data of the PMC/HMC series, please get directly in touch with us or consult the PMC/HMC catalogue.

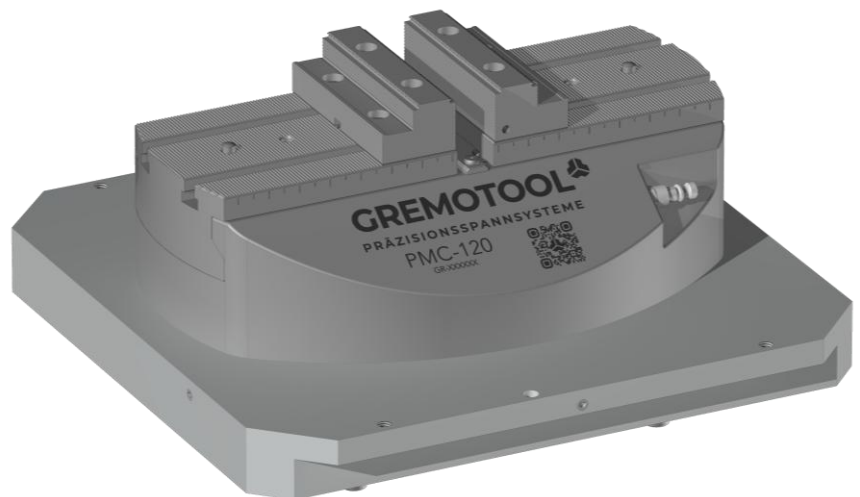

PMC-120 with System 3R Delphin 398 Pallet

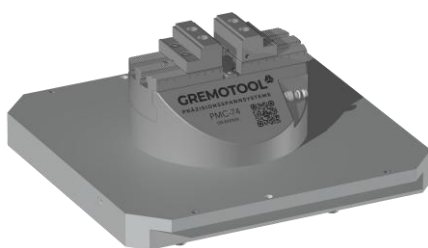

**PMC-74 with System 3R
Delphin 398 Pallet**

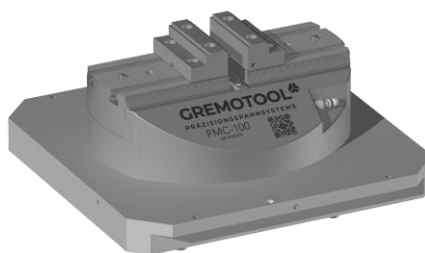

**PMC-100 with System 3R
Delphin 398 Pallet**

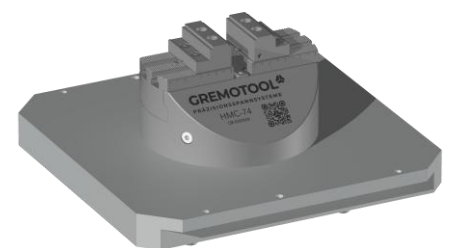

**HMC-74 with System 3R
Delphin 398 Pallet**



**HMC-100 with System 3R
Delphin 398 Pallet**



**HMC-120 with System 3R
Delphin 398 Pallet**



**2x PMC-74 with System 3R
Delphin 448 Pallet**

Further variants can be requested directly by Gremotool.

The shown products and option combinations are examples.
The rights by the respective products are the property of System 3R and/or Gremotool.

Variant table

System 3R Delphin with SC

mechanical

The SC series can be mounted on the Delphin pallets from System 3R without any modifications.

The height of the SC series enables optimum accessibility for 5-axis machining on workpieces.

The large range of jaws also offers suitable jaws for any application.

For the exact data of the SC series, please get directly in touch with us or consult the SC catalogue.

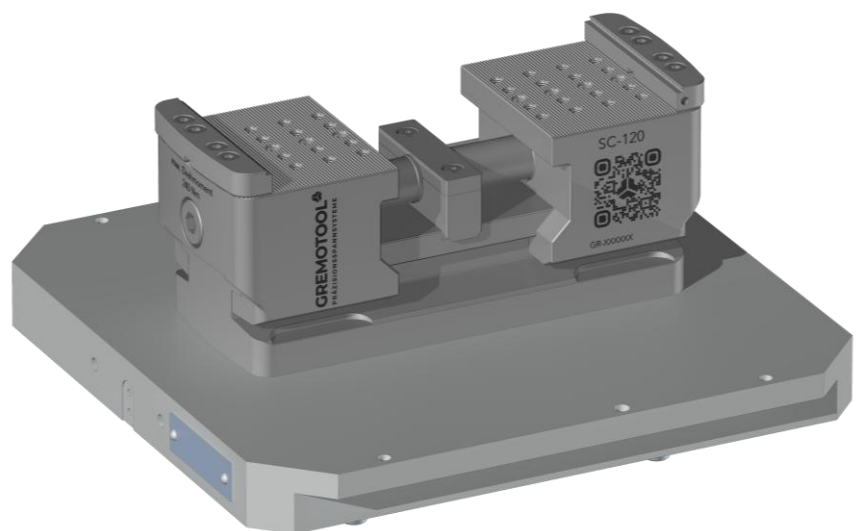

SC-120 with System 3R Delphin 398 Pallet

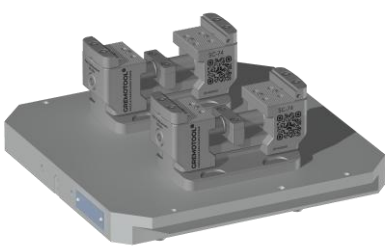

**2x SC-74 with System 3R
Delphin 398 Pallet**

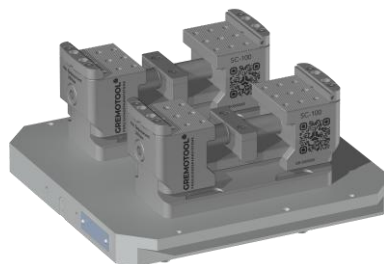

**2x SC-100 with System 3R
Delphin 398 Pallet**

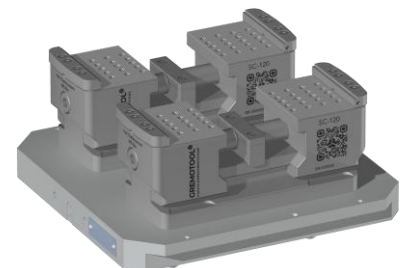

**2x SC-120 with System 3R
Delphin 398 Pallet**

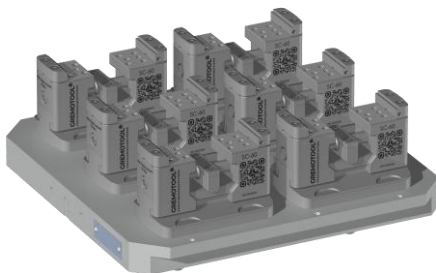

**6x SC-60 with System 3R
Delphin 448 Pallet**

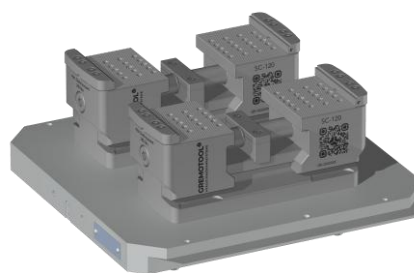

**2x SC-120 with System 3R
Delphin 448 Pallet**

Further variants can be requested directly by Gremotool.

The shown products and option combinations are examples.
The rights by the respective products are the property of System 3R and/or Gremotool.

Variant table

System 3R Delphin with VC

mechanical

The VC series can be mounted on the bore hole grid panels and on the Delphin pallets from System 3R without modifications.

The modular design of the clamping system allows the clamping device to be customised to the respective application.

The large range of jaws also offers suitable jaws for any application.

For the exact data of the VC series, please get directly in touch with us or consult the VC catalogue.

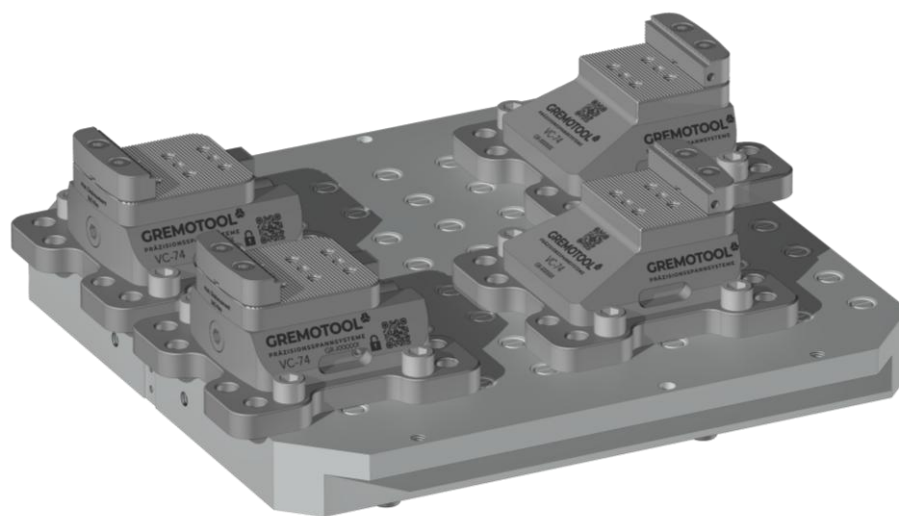

2x VC-74 with System 3R Delphin 398 Pallet



**3x VC-74 with System 3R
Delphin 398 Pallet**

Further variants can be requested directly by Gremotool.

The shown products and option combinations are examples.
The rights by the respective products are the property of System 3R and/or Gremotool.

Variant table

System 3R Delphin with LC

mechanical

The LC series can be mounted on the Delphin pallets from System 3R without any modifications.

Due to the closed design of the LC series, no chips remain on the clamping device.

The large range of jaws also offers suitable jaws for any application.

For the exact data of the LC series, please get directly in touch with us or consult the LC catalogue.



LC-120 with System 3R Delphin 398 Pallet



**LC-150 with System 3R
Delphin 398 Pallet**



**2x LC-74 with System 3R
Delphin 398 Pallet**



**2x LC-100 with System 3R
Delphin 398 Pallet**



**2x LC-120 with System 3R
Delphin 398 Pallet**



**2x LC-120 with System 3R
Delphin 448 Pallet**



**2x LC-150 with System 3R
Delphin 448 Pallet**

Further variants can be requested directly by Gremotool.

The shown products and option combinations are examples.
The rights by the respective products are the property of System 3R and/or Gremotool.

mechanical

Variant table

System 3R Delphin with RC

The RC-series can be mounted on the pore hole grid panels and on the Delphin pallets form System 3R without modifications.

The modular design of the RC-series allows different clamping situations for the workpieces.

The quick-change jaw system offers a pull-down function and the right jaw for the workpieces.

For the exact data of the RC series, please get directly in touch with us or consult the RC catalogue.

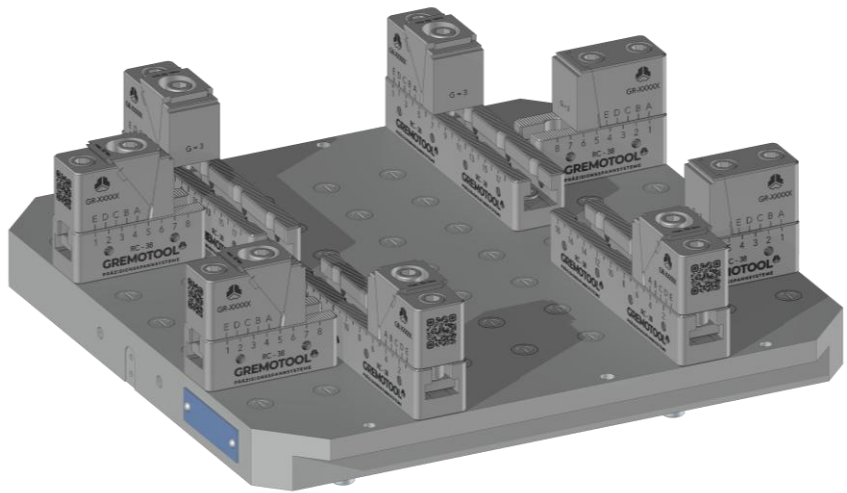

4x RC-38 with System 3R Delphin 448 Pallet

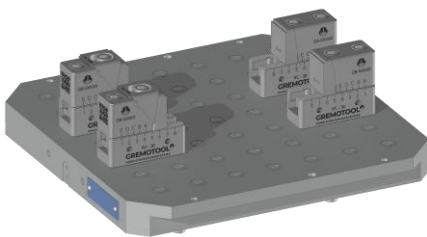

2x RC-38 with System 3R Delphin 398 Pallet

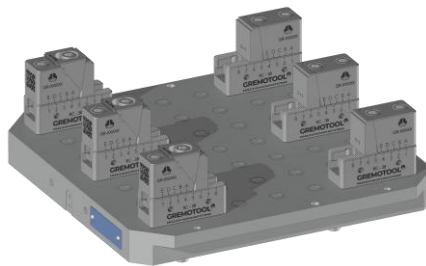

3x RC-38 with System 3R Delphin 398 Pallet

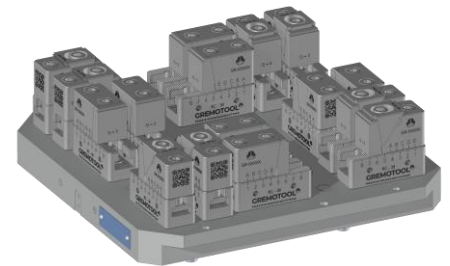

8x RC-38 with System 3R Delphin 398 Pallet

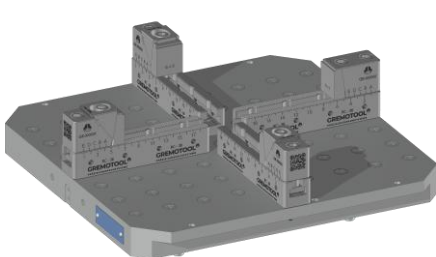

2x RC-38 with System 3R Delphin 448 Pallet

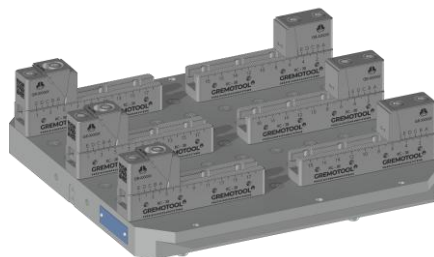

3x RC-38 with System 3R Delphin 448 Pallet

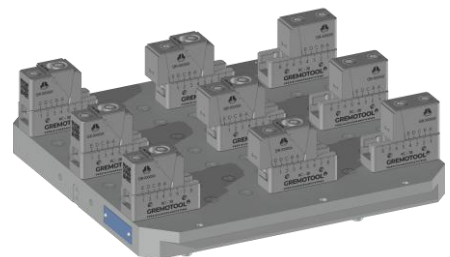

3x RC-38 with System 3R Delphin 448 Pallet

Further variants can be requested directly by Gremotool.

The shown products and option combinations are examples. The rights by the respective products are the property of System 3R and/or Gremotool.

Applications

Zero-point clamping systems

The System 3R centring elements can be attached directly to the clamping system to generate fewer interfaces.

If further requirements are placed on the clamping systems, these can be integrated into the pallet geometries. This frees up several millimetres of machining space without compromising the functionality or automation capability of the clamping devices.

Special dimensions are another way of optimising the space required for production.

For these suggested solutions, please get directly in touch with us.



2x LC-150k with System 3R Delphin 398 Pallet



**SC-50k with System 3R
Macro Pallet**



**LC-50 with integrated System 3R
GPS-120 Pallet automatable**

Further variants can be requested directly by Gremotool.

The shown products and option combinations are examples.
The rights by the respective products are the property of System 3R and/or Gremotool.

Applications

Gremotool Fixture

Today's cost-effective production requires flexible solutions for maximum efficiency. We can contribute to maximum utilisation of the processing machine with towers, prisms, or pyramids.

For suggested solutions in multiple clamping, please get directly in touch with us.

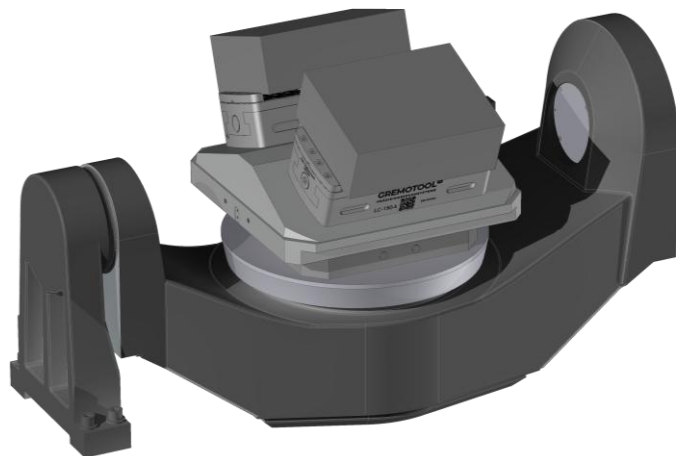

2x LC-150k with prism on System 3R Delphin 398 Pallet

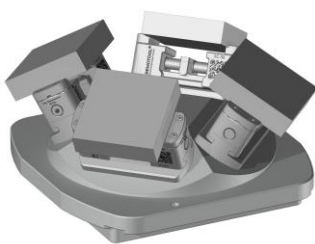

4x SC-50 with Pyramid on System 3R Dynafix Pallet

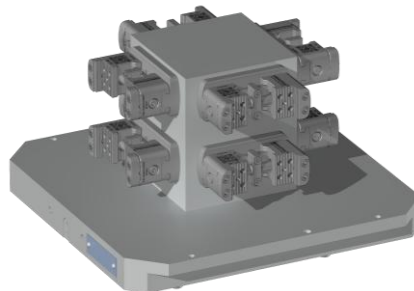

8x SC-40 with Tower on System 3R Delphin 398 Pallet



Tower with Delphin Short zero-point chuck

Further variants can be requested directly by Gremotool.

The shown products and option combinations are examples.
The rights by the respective products are the property of System 3R and/or Gremotool.

Accessories

Gremotool range of jaws

Each clamping system is supplied with a pair of gripper jaws allowing to clamp unmachined parts at no additional costs.

Jaw width [mm]		34	40	50	60	74	100	120	150
SC-gripper jaw flat	Nr. 837110	X	X	X	X	X	X	X	X
SC-gripper jaw	Nr. 837150	X	X	X	X	X	X	X	X
Standard gripper jaw	Nr. 837250	X	X	X	X	X	X	X	X
High gripper jaw	Nr. 837300	X	X	X	X	X	X	X	X
Combi jaw	Nr. 837350	X	X	X	X	X	X	X	X
Automation gripper jaw	Nr. 837380	X	X	X	X	X	X	X	X
Automation step jaw	Nr. 837400	X	X	X	X	X	X	X	X
Step jaw flat	Nr. 837410	X	X	X	X	X	X	X	X
Standard step jaw	Nr. 837450	X	X	X	X	X	X	X	X
Prism jaw	Nr. 837500	X	X	X	X	X	X	X	X
Soft jaw Aluminium	Nr. 837702	X	X	X	X	X	X	X	X
Soft jaw Steel	Nr. 837703	X	X	X	X	X	X	X	X

For the exact data of the jaws, please consult the jaw catalogue.

Accessories

Gremotool range of jaws

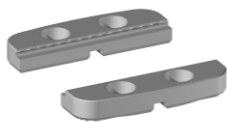

Nr. 837110

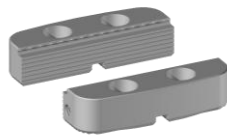

Nr. 837150

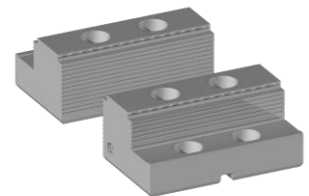

Nr. 837250

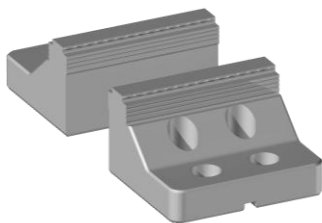

Nr. 837300

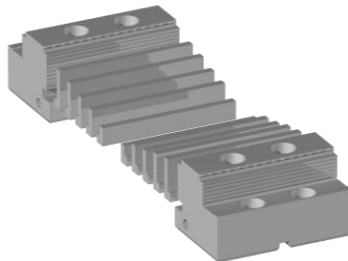

Nr. 837350

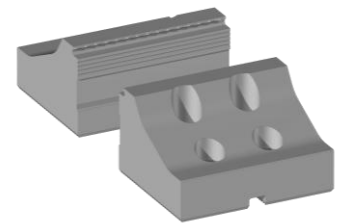

Nr. 837380

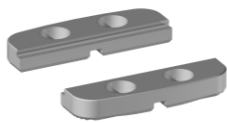

Nr. 837410

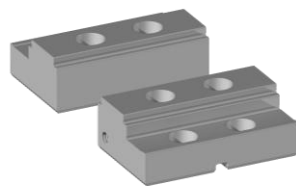

Nr. 837450

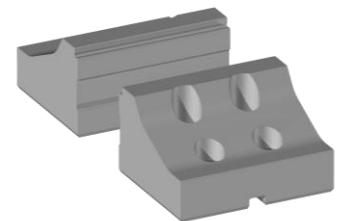

Nr. 837480

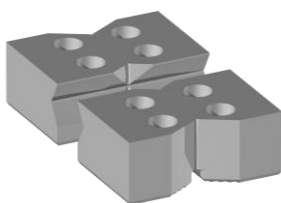

Nr. 837500

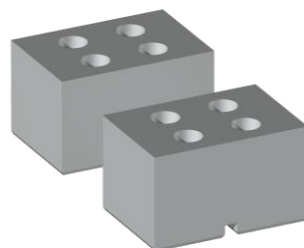

Nr. 837702

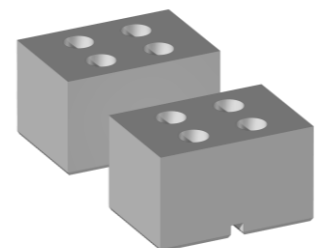

Nr. 837703



Imprint

Gremotool GmbH
Wilerstrasse 3
CH-9200 Gossau
Schweiz

www.gremotool.ch
info@gremotool.ch
+41 (0)71 930 03 90

Our general terms and conditions apply, which can be accessed at www.gremotool.ch. Further catalogues can be downloaded from the website www.gremotool.ch.

Commercial Register:
UID-Nr. CHE-498.310.590

This document is protected by copyright. All rights reserved. Any use, even partial use, in particular publication, duplication, distribution, reproduction, processing and/or modification, requires the prior written authorisation of Gremotool GmbH. Misprints, errors, and technical changes reserved.

Publication March 2025, 2nd Edition

